

SELECTOR GUIDE

Nautilair[®]

Combustion Blowers

- High temperature options
- Moisture resistant silicone coated PCB options
- Multiple electrical wiring options
- Configurable speed control profiles
- Custom speed set points, ramps and more

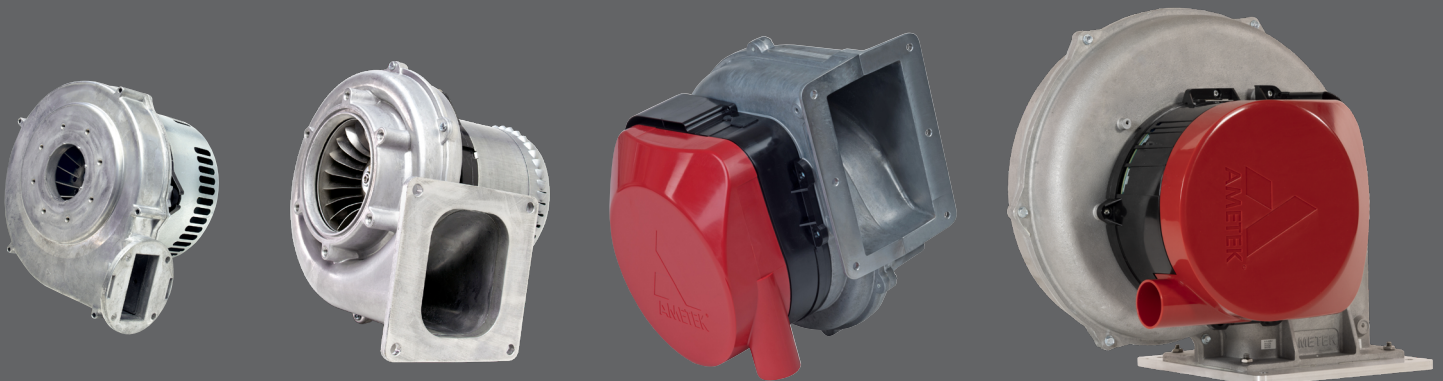

Sizing the Proper Nautilair® Blower for Your Combustion Application

Application Information

AMETEK Dynamic Fluid Solutions (DFS) designs Nautilair® Combustion Blowers to deliver a measured air/fuel mixture in gas-fired burner systems for optimized combustion and reduced nitrous oxide and carbon monoxide emissions.

All Nautilair blowers are designed to accept several different gas valves that attach directly to the inlet of the blower.

Mechanical Characteristics

Nautilair blowers are designed for combustion applications and are typically mounted directly to the inlet of the burner. The fan housings are sealed to allow for the combustion gas and air to mix inside the blower. Fans have been designed to optimize air/gas mixtures and provide high efficiency combustion. Their design uses an offset motor that allows for higher temperatures and condensation in the fan housing without effecting the blower PC board.

There are four sizes of blowers: 7.6", 8.9", 12.3" and 14". We have versions of each model with varying degrees of performance, and we can customize the blower to meet your needs.

Electrical Characteristics

The motor controller uses a digital signal processor (DSP) drive to control the speed of the blower. It is completely programmable for various speed profiles and several different speed signals (0–10VDC, PWM, 4–20mA, and mechanical).

Nautilair blowers have an optional internal speed control circuit that will maintain a specific speed regardless of load or supply voltage. This allows for a constant speed in areas of fluctuating supply voltages or varying pressures.

Selected AMETEK DFS blowers have the ability to accept **Universal Voltages**. One benefit of this option is the ability to use the same blower in applications installed anywhere in the world, without the need of a transformer. The **Common Performance** option standardizes the performance so that the blower output is the same while being run at any input voltage. In the case of voltage spikes, or the system being installed in a different location, the air performance remains constant.

Nautilair blowers are more powerful than many competitive blowers at the same size.

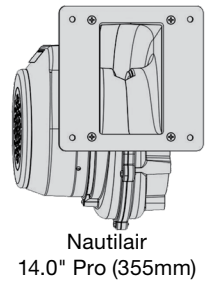
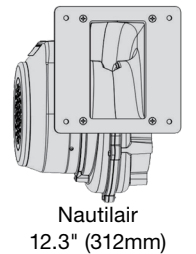
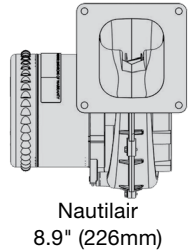
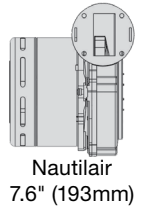

Product Configuration

Follow the steps below to seamlessly fit Nautilair Combustion Blowers into your applications.

1 Sizing Based on Performance Requirement

This chart can be used to identify the proper Nautilair family required based on the output of your application (BTU). Depending on the system resistance (pressure drop) of your system, it may be possible that multiple blower models may be suitable.

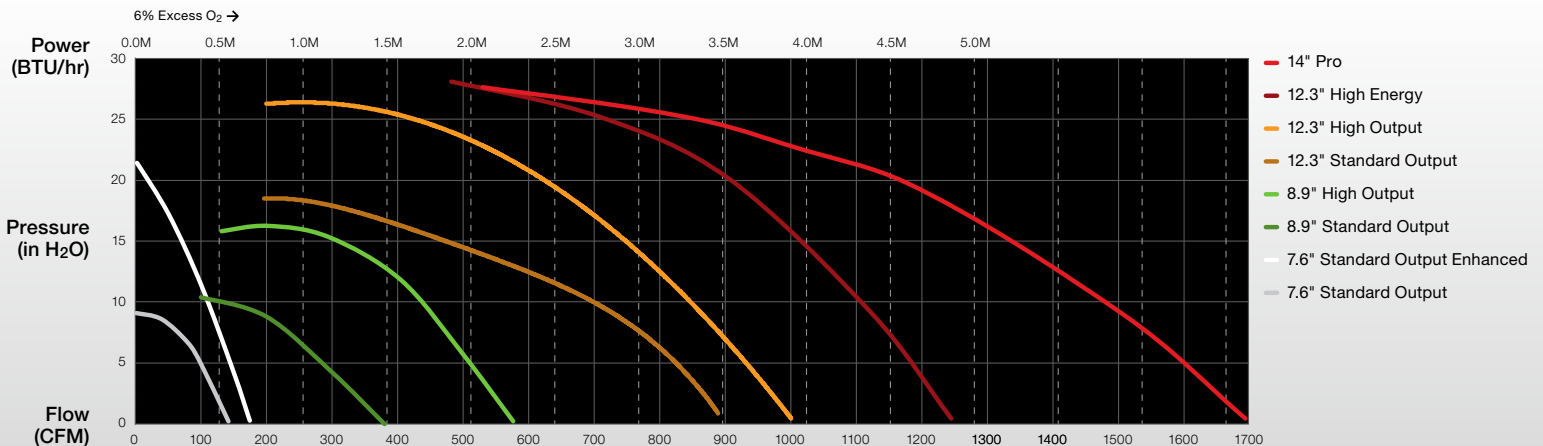

2 Determine Outlet Flange Size

Nautilair blowers have been optimized to fit into many standard combustion applications. Outlet flange options allow for the blower to bolt up to each specific application with minimal modification of the system.

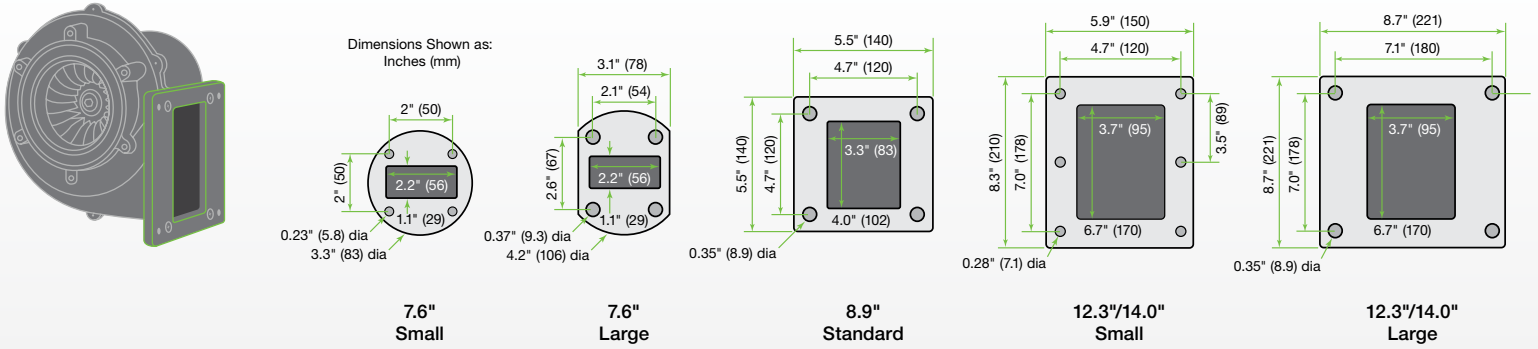

3 Determine Input Voltage and Control

Options for input voltage as well as control types makes the Nautilair lineup of blowers adaptable to a wide variety of applications. Depending on the application, the blower can be configured for open or closed loop control. In closed loop control, a specific speed control command, say 5VDC, is correlated to a specific blower speed, say 8,000 RPM. If the system resistance (pressure) changes the speed will be maintained. Open loop allows for the speed to vary according to the system resistance.

Input Voltages	Speed Control Inputs	Speed Control Options
120 VAC 230/240 VAC 1 Phase 230/240 VAC 3 Phase 380-575 VAC 3 Phase	Mechanical Potentiometer 0-10 VDC PWM 4-20 mA	Open Loop Closed Loop

4 Determine Inlet/Gas Valve Mounting

All Nautilair blowers are designed to accept several different gas valves that attach directly to the inlet of the valves from Honeywell, Karl Dungs, SCC and Kromshroder. Your AMETEK DFS sales representative can help you to determine the suitable inlet configuration to match the gas valve being used. Unique bolt patterns, tapped holes, O-ring grooves, and gasket locating features are only a few of the options available.

BTU Range of Nautilair Combustion Blowers

BTU/hr 0 500,000 1M 1.5M 2M 2.5M 3M 3.5M 4M 4.5M 5M

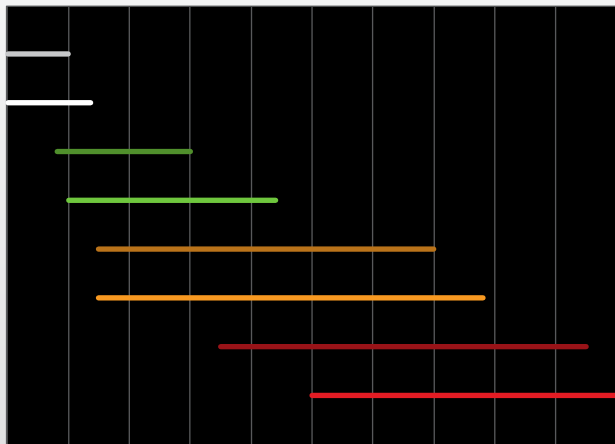

- 14" Pro
- 12.3" High Energy
- 12.3" High Output
- 12.3" Standard Output
- 8.9" High Output
- 8.9" Standard Output
- 7.6" Standard Output Enhanced
- 7.6" Standard Output

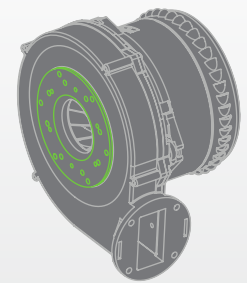

Adaptations / Options

- O-Ring Groove
- Bolt Patterns
- Tapped Holes
- Gasket Keeper

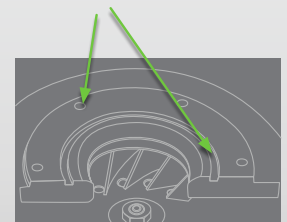

kW 147 293 440 586 733 879 1,026 1,172 1,319 1,465

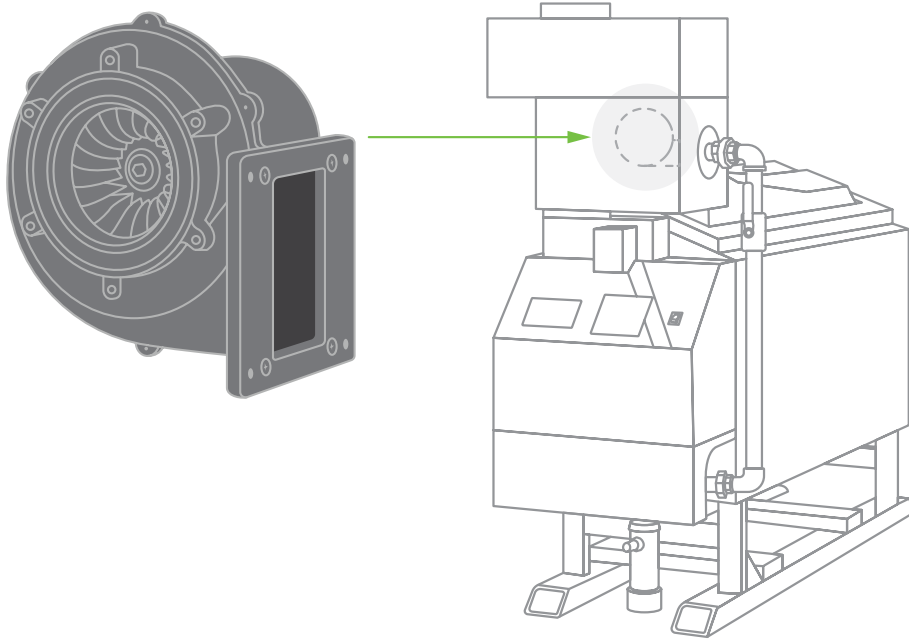

AMETEK, Inc.

AMETEK is a global leader in electronic instruments and electromechanical devices with colleagues at numerous manufacturing, sales and service locations in the United States and in many other countries around the world.

AMETEK Dynamic Fluid Solutions

For more than 100 years, AMETEK Dynamic Fluid Solutions (DFS) has helped OEMs differentiate their products by developing robust, flexible and durable blowers, motors and pumps under the brand names – Lamb®, Nautilair®, Prestolite Motors, ROTRON® Regenerative Blowers, ROTRON® Transportation and Windjammer®.

Our engineering experts understand technical challenges and can provide OEMs so much more than an off-the-shelf part. We are a true technology partner, offering customizable and collaborative fluid-moving solutions.

AMETEK DFS has worldwide sales representative support, research facilities and three manufacturing sites in the United States, China and Mexico.

The company is headquartered in Kent, OH, which is also home to a state-of-the-art engineering laboratory that helps customers expedite agency certifications, performance testing, prototyping and more.

AMETEK
DYNAMIC FLUID SOLUTIONS
AMETEKDFS.com