









weber[®]
cleaning parts



Vacuum cleaner accessories
Suction and drain hoses
Filters

Table of contents

Vacuum cleaner nozzles		Page
Combination nozzles	 Economy Line	D 272, D 306DKS, D 307, RD 270, RD 285, RD 295 K 270, K 300 8
Hard floor nozzles	 ProfiLine Pullman System Economy Line	D 300, D 360, D 370 MK 375, MK 400 12 13 14
Commercial and industrial nozzle		15
Commercial nozzle	 ProfiLine	GRD 370, GRD 450 MAL 450 16
Industrial nozzle		IRD 500 17
Turbo nozzles	Polsterturbodüse	TB 155 19
	 Economy Line	TK 286 KC 280 20 20
Suction nozzles / upholstery nozzles / crevice nozzles	 Economy Line	21 - 23
Suction hoses and accessories		
Suction hoses roll goods	with fabric reinforcement	24
	sockets and connector	24
	standard hose	25
	hand pipe bends	25
	sockets and connectors	26
	electrically conductive	27
antistatic	27	
sleeve electrically conductive /	27	
antistatic oil resistant	27	
Suction and drain hoses		
Suction hoses „assembled“	for cleaning machines	28 - 29
	for suction cups	30 - 31
Drain hoses „ready made“	for pump suction (Storz coupling)	31
Extension tubes		
	telescopic tubes	32
	stainless steel pipes,	32
	chrome plated pipes	32
Filters for vacuum cleaners		
	flat pleated filters, filter cartridges and chip screens for vacuums, dust filter bags	33 - 36

From one expert to another

Whether floor nozzles, stainless steel and telescopic pipes, suction hoses, accessories or spare parts – Weber Cleaning Parts covers the entire range for professional users and the specialised trade. Quality products for (almost) all vacuum cleaners.



Combination nozzles





Combi nozzles – Powerful all-rounders for everyday use



Combi nozzles are multifunctional and are included in most hoovers as standard equipment. They are used in private and commercial environments for dry vacuuming. A mechanism allows the integrated bristle ring to be retracted or extended. For vacuuming carpets, the bristle ring should be retracted. When cleaning hard floors, the floor is cleaned with the bristle ring extended. The bristle ring prevents the floor from being scratched and ensures a better suction result.

The working widths of the individual hard floor nozzles vary between 270 mm and 300 mm. The combi-nozzles are available with different features: with or without castors as well as a very flat version for cleaning under overlooked areas.

Suitable for

-  Hard floors
-  Carpet
-  Dry

D 272

For textile and hard floors (switchable)



D 272, without shock cord

Connectors* Ø in mm	Art. No.
32	892015.272032
35	892015.272035

*other connectors on request.

FOR EASY CLEANLINESS

Universal Hoover nozzle for hard floors & carpet without castors

Advantages

- Robust and compact
- Effective even with low suction power
- Optimum fibre pick-up

Features

- Plastic swivel/tilt joint socket
- 2-slot gliding sole (nickel-plated) with 2 thread lifters
- made of slanted bristle velour (exchangeable)
- Incl. 2 PP brush strips

D 306DKS

For textile and hard floors (switchable)



Connectors* Ø in mm	Art. No.
32	892023.306032
35	892023.306035
36	892023.306036
38	892023.306038

*other connectors on request.

CLEAN RATIONALLY WITH SAFETY

Universal Hoover nozzle with soft bumper band for furniture protection

Advantages

- High area performance
- Effective even with low suction power
- Large suction mouth
- With soft bumper band to protect furniture

Features

- Plastic swivel/tilt joint socket
- 2-slot gliding sole (nickel-plated) with 2 thread lifters made of slanted bristle velour (exchangeable)
- incl. 2 PP brush strips

D 307

For textile and hard floors (switchable)



POPULAR IN HOTELS & RESTAURANTS
Universal Hoover nozzle for hard floor and carpet care in hotels & restaurants

Advantages

- High area performance
- Effective even with low suction power
- Large suction mouth

Features

- Plastic swivel/tilt joint socket
- 2-slot gliding sole (nickel-plated) with 2 slanted bristle velour thread lifters (exchangeable)
- incl. 2 PP brush strips

D 307, incl. 2 brush strips (PP)

Connectors* Ø in mm	Art. No.
32	892022.306132 with parking hook ①
35	892022.306135 with parking hook ①
36	892022.306036
38	892022.306038

*other connectors on request

RD 270

For textile and hard floors (switchable)

X *Our value-for-money tip!*



„LITTLE SISTER“ OF THE RD 295
with differentiation potential Smooth-running universal Hoover nozzle with plastic sliding soleplate

Advantages

- High quality workmanship
- Thorough due to long, wide thread lifters
- Good suction power

Features

- Plastic swivel/tilt joint spigot
- Large castor
- Suitable for EU energy label-optimised vacuum cleaners with a power < 900 W

RD 270, incl. brush strip front

Connectors* Ø in mm	Art. No.
32	892040.270132 with parking hook ①
35	892040.270135 with parking hook ①

*other connectors on request

RD 285

For textile and hard floors (without switching)



Extremely absorbent!

HOOVER NOZZLE FOR HAND and floor vacuum cleaner Extra flat construction and slim design

Advantages

- Flat design
- Functional construction
- Extremely absorbent

Features

- Plastic swivel/tilt joint socket
- Integrated smooth-running castors, guide rollers
- No need to switch from textile to hard floors

RD 285, incl. 2 sealing lips

Connectors* Ø in mm	Art. No.
32	892035.285032
35	892035.285035

*other connectors on request

RD 295

For textile and hard floors (switchable)

X *high-end product!*



For EU-energy label-optimised vacuum cleaners

ENJOY THE PEACE AND QUIET Noise-reduced hoover nozzle with high performance

Advantages

- High quality workmanship
- Thorough due to long and wide thread lifters
- Nickel-plated steel sliding sole

Features

- Plastic swivel and double tilt joint spigots
- Large castor
- Noise-reduced version
- Suitable for EU energy label optimised vacuums with a power < 900 W

RD 295, incl. 2 PP brush strips

Connectors* Ø in mm	Art. No.
32	892032.295032
32	892032.295132 with parking hook ①
35	892032.295135 with parking hook ①
36,65	892032.295036U
38	892032.295038

*other connectors on request

EconomyLine – combi nozzles

Combi nozzles

K 270



Features

- Plastic swivel/tilting joint spigot
- PP top part
- PP brush strips
- Steel sole (nickel-plated) with thread lifter

K 270

Connectors* Ø in mm	Art. No.
Universal 32 – 38	891050.270001
32	891050.270032
35	891050.270035
36,65	891015.000000
38	891050.270038
Hitachi	891050.270002

*other connectors on request

K 300



Features

- Plastic swivel/tilting joint spigot
- PP top part
- PP brush strips
- Steel sole (nickel-plated) with thread lifter

K 300

Connectors* Ø in mm	Art. No.
32	891050.300032
35	891050.300035

*other connectors on request

Hard floordüsen



Hard floor nozzles – All-purpose use on hard floors



Hard floor nozzles are used in private and commercial environments. Applications vary from dry to wet vacuuming in the basement, garage, workshop and commercial cleaning. All our hard floor nozzles combine the following advantages: They are **hard-wearing**, **practical** and **comfortable to use**. They are also easy to clean.

The working widths of the individual hard floor nozzles are between 300 mm and 400 mm. The more powerful the vacuum cleaner is equipped, the wider hard floor nozzles can be used. For use on sensitive floors we recommend **soft horsehair bristles**, on non-sensitive floors **poly bristles** for maximum cleaning power and for wet vacuuming **rubber lips**. Rollers prevent the nozzle from sticking to the floor. Rollers are included in the standard version of Wessel Werk hard floor nozzles.

Suitable for

Hard floor

•••••

Dry

•••••

Wet

D 300



**ALWAYS CONFIDENT ON
ON DIFFICULT SURFACES**
Hard-wearing all-purpose nozzle
for textile and hard floors

Advantages

- Standard connections for almost all vacuum cleaner types
- Easy to clean

Features

- Plastic swivel joint support
- 2 castors (soft coating)
- Incl. brush or rubber strips

Hard floordüsen

D 300 Dry, incl. brush strips (poly)

Connectors* Ø in mm	Art. No.
32	892016.300032
35	892016.300035
36,65	892016.300036
38	892016.300038
System Hitachi (35 mm exterior)	892016.300099

*other connectors on request

D 300 Wet, incl. rubber strips

Connectors* Ø in mm	Art. No.
32	892017.300032
35	892017.300035
36,65	892017.300036
38	892017.300038

*other connectors on request

D 360



GUARANTEED NOT TO BE AFRAID OF WATER
Robust all-purpose nozzle for wet & dry vacuuming
in trade and industry

Advantages

- High area coverage
- Excellent handling
- Tread strips made of robust special rubber

Features

- Plastic swivel joint support
- 2 castors (soft coating)
- Incl. brush or rubber strips (also oil-resistant variants)

D 360 Dry, incl. brush strips (poly)

Connectors* Ø in mm	Art. No.
32	892018.360032
35	892018.360035
36,65	892018.360036
38	892018.360038
41	892018.360041

*other connectors on request

D 360 Wet, incl. rubber strips

Connectors* Ø in mm	Art. No.
32	892019.360032
35	892019.360035
36,65	892019.360036
38	892019.360038
41	892019.360041

*other connectors on request

D 370R



IN SEARCH OF PROFESSIONAL APPLICATIONS
Wet & dry suction nozzle for
all-purpose use in trade and industry

Advantages

- Easy to clean
- High area coverage

Features

- Plastic swivel joint support
- 2 castors (soft coating)
- Incl. 2 brush or rubber strips

D 370R Dry, incl. brush strips (poly)

Connectors* Ø in mm	Art. No.
32	892020.370032U
35	892020.370035

*other connectors on request

D 370R Wet, incl. rubber strips

Connectors* Ø in mm	Art. No.
32	892021.370032
35	892021.370035

*other connectors on request

Spare parts hard floor nozzles

Spare part	D 300	D 360	D 370R
Brush strips (Poly)	391504.109000	391505.109000	391503.109000
Rubber strips	911511.000000	911512.000000	911510.000000
Perbunan strips (oil resistant)	on request	on request	on request
Castors (incl. axle)	892108.000000	892108.000000	892115.000000
Castor holder			892113.000000
Glider			892115.000100

Brush strips (Poly)



Dry

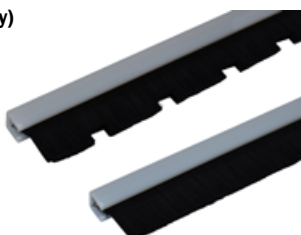

Rubber strips



Wet

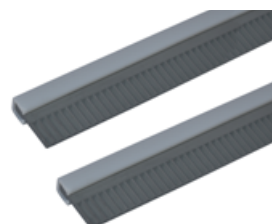

ProfiLine – hard floor nozzles

For dry and wet vacuuming of textile and hard floors

Hard floordüsen

MK 375



Advantages

- Lightweight and easy to handle
- Easy to change attachments and pick-up nozzles

Features

- Plastic swivel joint nozzle and housing
- Incl. attachment for dry, wet and carpet cleaning
- With skids or castors depending on attachment

MK 375 (dry, wet and carpet)

Connectors* Ø in mm	Art. No.
32	892050.375032
35	892050.375035
36,65	892050.375036
38	892050.375038

*other connectors on request

MK 400



Advantages

- For powerful vacuum cleaners
- For large areas
- Easy replacement of brush and rubber strips as well as pick-up nozzles

Features

- Plastic swivel joint support
- 2 castors
- Incl. brush and rubber strips

MK 400 (Dry und Wet)

Connectors* Ø in mm	Art. No.
32	892051.400032
35	892051.400035
36,65	892051.400036
38	892051.400038
40	892051.400040
50	892051.400050
58	892051.400058

*other connectors on request

Reducing bushing standard

Connectors Ø in mm	Art. No.
from 35 to 32	892126.000000

Reducing bushing rimmed

Connectors Ø in mm	Art. No.
from 35 to 32	892127.000000

Spare parts ProfiLine hard floor nozzle

Spare part		MK 375	MK 400
Dry insert		892150.000020	
Wet insert		892150.000010	
Carpet insert		892150.000030	
Connection piece	NW 32 mm	892151.000032	892152.000032
	NW 35 mm	892151.000035	892152.000035
	NW 36 mm	892151.000036	892152.000036
	NW 38 mm	892151.000038	892152.000038
	NW 40 mm		892152.000040
	NW 50 mm		892152.000050
	NW 58 mm		892152.000058
Click ring		892121.000000	892122.000000
Brush strips (Poly)			391511.109000
Rubber strips			911513.000000

vacuum insert

carpet insert

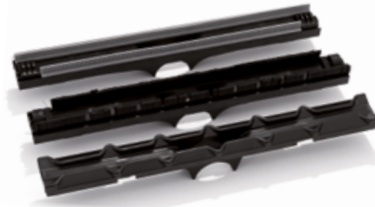

Rubber strip

brush strip (Poly)

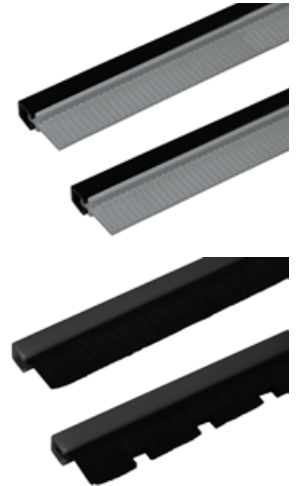

Pullman system

Fitting for Clean Track + Redstreak



Article	Connectors* Ø in mm	Description	Art. No.
Metal pipes (2 Stück)	38	S-pipe – 670 mm per pipe	891024.000000
Water vacuum nozzle	38	with squeegee grey	891025.000100
Squeegee grey		425/45 mm	911502.000000
Dry vacuum nozzle	38	with brush strip	891026.000100
Crevice nozzle	44		891027.000000
Furniture brush	44		891028.000000
Squeegee grey		425/45 mm	911502.000000

*nominal width (NW) = inner diameter

EconomyLine – hard floor nozzles

H 300 with plastic bristles



Features

- Plastic swivel joint
- 2 castors
- Incl. brush strips (poly)

H 300

Connectors* Ø in mm	Art. No.
32	891052.300032
35	891052.300035

*other connectors on request

Hard floor nozzles

H 300R with horsehair bristles



Features

- Plastic swivel joint
- 2 castors
- Incl. very soft natural brush strips

H 300R

Connectors* Ø in mm	Art. No.
32	891053.300032
35	891053.300035

*other connectors on request

H 300N with rubber strips for wet vacuuming



Features

- Plastic swivel joint
- 2 castors
- 2 rubber strips not replaceable

H 300N

Connectors* Ø in mm	Art. No.
32	891052.300032N
35	891052.300035N

*other connectors on request

Commercial and industrial nozzles





**Robust all-purpose nozzles for commercial use
Reliability even under the toughest conditions**



Commercial and industrial nozzles combine all the advantages of hard floor nozzles and are used in industrial and commercial environments. Industrial nozzles are manufactured from a robust die-cast aluminum housing. Due to the high quality, they impress with their efficiency, durability and reliability. Attributes that are important in the modern working environment.

The working widths of the individual industrial nozzles vary between 375 mm and 500 mm. **The more powerful the vacuum cleaner is equipped, the wider the industrial nozzles can be used.** It is best to use poly brush strips for vacuuming dry dirt. We recommend **rubber lips** for wet vacuuming liquids that do not contain oil and grease or hydraulic fluids. For all other applications in kitchens, workshops, fire departments and industry, we recommend oil-resistant Perbunan lips. Perbunan lips can be recognized by their black color. These are only available for industrial nozzles from Wessel Werk. All industrial nozzles are equipped with height-adjustable castors. These prevent the nozzle from sticking to the floor.

Suitable for

-  Hard floor
-  Dry
-  Wet

GRD 370



TAKES ON ANY CHALLENGE
Indestructible wet & dry suction nozzle
for commercial and industrial environments

Advantages

- Robust, insensitive nozzle
- Easy to clean
- Infinitely adjustable height

Features

- Die-cast aluminum body
- Plastic swivel joint support
- 2 castors (height-adjustable)
- Incl. brush or rubber strips (also oil-resistant versions)

GRD 370 dry, incl. brush strips (poly)

Connectors* Ø in mm	Art. No.
32	892039.370032
35	892039.370035
37	892039.370037
38	892039.370038
41	892039.370041

*other connectors on request

GRD 370 wet, incl. rubber squeegees

Connectors* Ø in mm	Art. No.
32	892038.370032
35	892038.370035
37	892038.370037
38	892038.370038
41	892038.370041U

*other connectors on request

Industrial nozzles

MAL 450



Advantages

- For powerful vacuum cleaners
- For large areas
- Robust and durable
- Easy replacement of brush and rubber
- Strips as well as pick-up spigots

Features

- Die-cast aluminum body
- Plastic swivel joint support
- 2 castors (adjustable)
- Incl. brush and rubber strips

MAL 450 (dry und wet)

Connectors* Ø in mm	Art. No.
32	892060.450032
35	892060.450035
36,65	892060.450036
38	892060.450038
40	892060.450040
50	892060.450050
58	892060.450058

*other connectors on request

Reducing bushing standard

Connectors Ø in mm	Art. No.
from 35 to 32	892126.000000

Reducing bushing with edge

Connectors Ø in mm	Art. No.
from 35 to 32	892127.000000

GRD 450

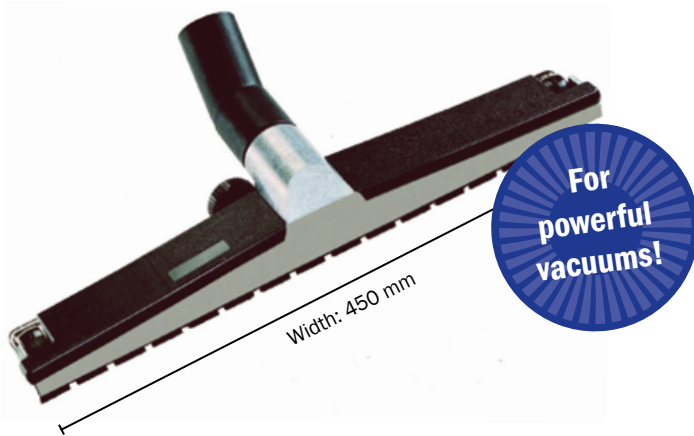

TAKES ON ANY CHALLENGE
Indestructible wet & dry suction nozzle
in XL format for professional use

Advantages

- Robust, insensitive nozzle
- Easy to clean
- Infinitely adjustable height

Features

- Die-cast aluminum body
- 2 castors
- Incl. brush or rubber strips (also oil-resistant versions)

GRD 450 Dry, incl. brush strips (poly)

Connectors* Ø in mm	Art. No.
35	891072.450035
38	891072.450038
41	891072.450041
50	891072.450050
58	891072.450058

*other connectors on request

GRD 450 Wet, incl. rubber strips

Connectors* Ø in mm	Art. No.
35	891069.450035
38	891069.450038
41	891069.450041
50	891069.450050
58	891069.450058

*other connectors on request

IRD 500

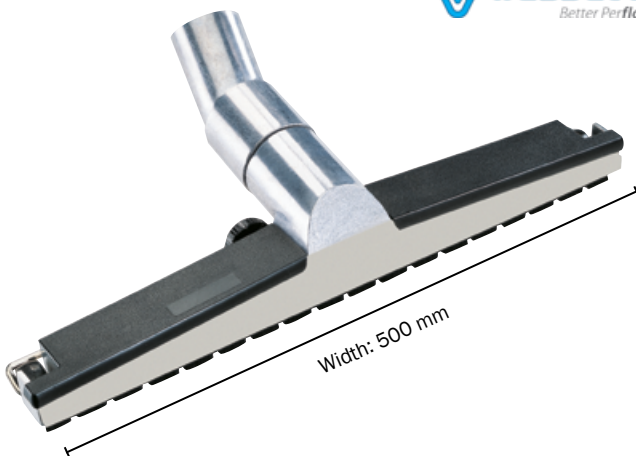

PLAYS IN A DIFFERENT LEAGUE
XXL industrial nozzle with height adjustment
and robust aluminum upper part

Advantages

- For powerful vacuum cleaners
- For large areas
- Height infinitely adjustable

Features

- Robust aluminum housing and aluminum swivel joint support
- 2 castors (adjustable)
- Incl. brush or rubber strips (also oil-resistant versions)

IRD 500 dry, incl. brush strips (poly)

Connectors* Ø in mm	Art. No.
50	891083.500050
58	891083.500058

*other connectors on request

IRD 500 wet, incl. rubber strips

Connectors* Ø in mm	Art. No.
50	891082.500050
58	891082.500058

*other connectors on request

Spare parts for commercial and industrial nozzles

Spare part	GRD 370	GRD 450	MAL 450	IRD 500
Brush strips (poly)	391502.109000	391500.109000	391510.109000	391501.109000
Rubber strips	911507.000000	911500.000000	911514.000000	911501.000000
Perbunan strips (oil-resistant)	911508.000000	911505.000000		911506.000000
Castor	892110.000000	892110.000000		892110.000000
Bracket for suction nozzle	892119.000000	892111.000000		892112.000000
Return screw for height adjustment	892118.000000	892118.000000		892118.000000

Brush strips (poly)

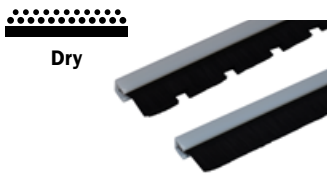

Rubber strips

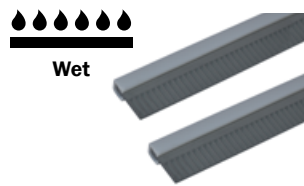

Perbunan strips(oil-resistant)



Return screw for height adjustments



Industrial nozzle Workhorse for heavy-duty work

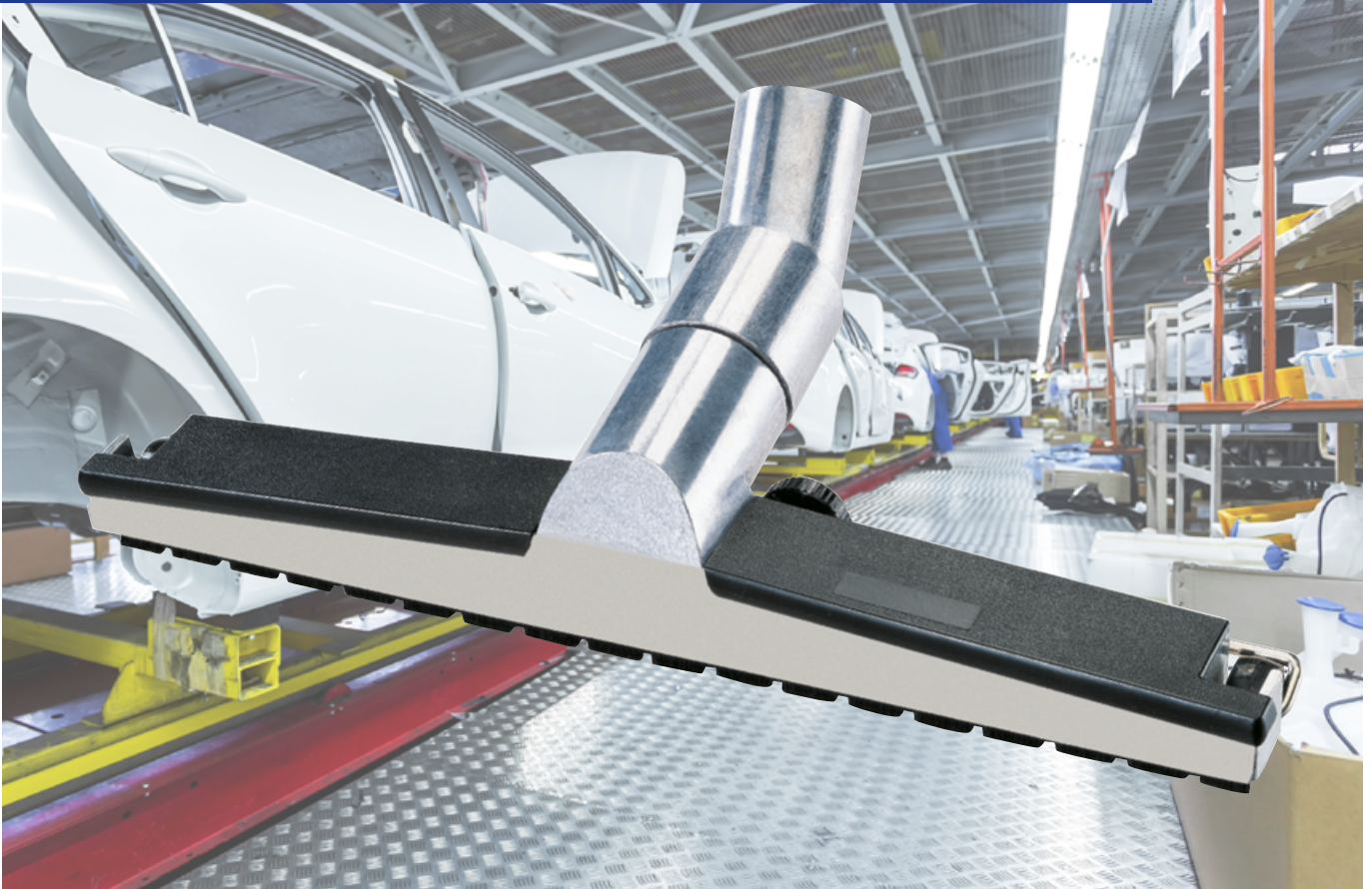

Turbo nozzles



Turbo nozzles are mainly used for **carpet cleaning**. The improved cleaning performance is achieved by rotating brush rollers, which are driven by the vacuum cleaner's air flow. The mechanical cleaning performance on carpets is maximized. Hair, pet hair, adhering dirt and crumbs are brushed out of the carpet fibers without damaging them.

During cleaning, the carpet fibers are visually refreshed and straightened. The working widths of the turbo nozzles vary from 155 mm to 280 mm. We recommend the TB155 hand nozzle for cleaning upholstered furniture. The wider versions are more suitable for cleaning floors. TK286 from Wessel Werk also offers the option of regulating the suction flow. The nozzle can be easily cleaned using the cleaning flap.

Suitable for

Hard floor

Carpet

Dry

TB 155

Hand turbo nozzle for upholstery fabrics and car seat



Thorough
and very
quiet!

Advantages

- Effective
- Handy
- Efficient

Features

- Flexibly mounted brush roller
- Turbine wheel with spherical bearing
- Toothed belt drive with sintered drive pinion (encapsulated)
- ABS upper part (textured surface)

TB 155

Connectors* Ø in mm	Art. No.
32	892065.155032
35	892065.155035

*other connectors on request

TK 286

For textile coverings and hard floors



ENERGY-CONSCIOUS PROFESSIONAL ATHLETE WITH PERFORMANCE GUARANTEE
Energy-efficient & noise-optimized turbo brush for energy-saving vacuum cleaners

Advantages

- Wear-resistant brush roller
- Manual suction flow regulation
- Easy to clean

Features

- Cleaning flap for turbine
- Toothed belt drive with sintered drive pinion
- 4 rollers with soft coating
- Suitable for EU energy label-optimized vacuum cleaners < 900 W

TK 286

Connectors* Ø in mm	Art. No.
32	892041.286132 mit Parkhaken
35	892041.286135 mit Parkhaken

*other connectors on request

EconomyLine – hard floor, combi and turbo nozzles

KC 280



Features

- Plastic swivel/tilt joint support
- Brush roller with robust fittings
- 4 castors with soft coating
- PVC lips for sealing

KC 280

Connectors* Ø in mm	Art. No.
32	891081.000000
35	891080.000000

*other connectors on request

Suction nozzles / upholstery nozzles / crevice nozzles

Vacuum cleaner accessories such as **suction nozzles, upholstery nozzles, crevice nozzles, clothes brushes, pipe cleaning brushes** and **furniture brushes** are important accessories that are needed for effective cleaning. Their use can speed up the cleaning of crevices, upholstery, furniture, pipes, picture frames, vases and much more. Every vacuum cleaner is only as good as the nozzle used.

Our product range includes crevice nozzles in various lengths and widths, furniture brushes, suction brushes with swivel holders, rubber suction tubes, clothes brushes and pipe cleaning brushes from Wessel Werk.

Suitable for vacuuming cracks, upholstery, furniture, pipes, picture frames, vases etc.

Furniture brushes



Furniture brush with swivel joint

Connectors Ø in mm	Bristles	Content shipping carton	Art. No.	Pic
29,75	poly black	84	892002.000030	①
32	poly black	84	892002.000032	①
35	poly black	84	892002.000035	①
35	Natural Hair (cattle hair)	84	892011.000035	



Furniture brush with swivel joint

Connectors Ø in mm	Bristles	Content shipping carton	Art. No.	Pic
32	round	100	891065.000000	②
35	round	130	891065.000035	②
36,65	round	130	891019.000001	②
38	round	100	891065.000038	②
44	round	100	891028.000000	②

Furniture brushes are available individually. Please ask for our attractive quantity scales.

Maxi oval

Suction brush with poly bristles



Connectors Ø in mm	Art. No.
32	891213.000032
35	891213.000035
36	891213.000036

Crevice nozzle FD 300



Connectors Ø in mm	Art. No.
32	892006.300032
35	892006.300035

Crevice nozzle EconomyLine



Connectors Ø in mm	Width in mm	content shipping carton	Art. No.	Pic
29,75	200	280	892003.200030	③
32	195	200	891051.195032	③
35	210	200	891051.210035	③
36,65	210	55	891018.000000	③
38	240	100	891064.000038	②
44	240	100	891027.000000	②

Crevice nozzles are available individually. Please ask about our attractive quantity discounts.

Crevice nozzle Big Mouth suitable for 891238.000000



Connectors Ø in mm	Art. No.
58	891073.000000

Crevice nozzle Maxi

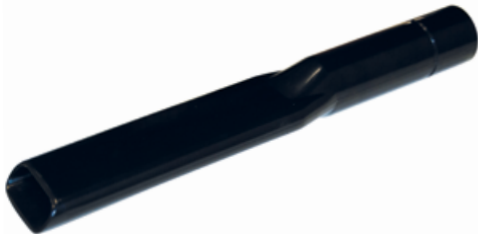

Connectors Ø in mm	Art. No.
ID 32 / AD 38	892024.237032

Crevice nozzle – extra long



Features

- Length: 635 mm
- 3-piece
- Impact-resistant plastic made from flexible elastomer

Connectors* Ø in mm	Art. No.
32 – 35	892008.000035

*Tapered connections, universally suitable for 32 – 35 mm

Crevice nozzle – flexible with suction hose connection



Features

- Ideal for self-service extraction stations
- Incl. sleeve and click ring
- Extremely stable and unbreakable

Connectors Ø in mm	Art. No.
38	891097.000038

Upholstery nozzles



ProfiLine

Connectors Ø in mm	Art. No.
29,75	892004.000030
32	892004.000032
34,9	892004.000035

EconomyLine

Connectors Ø in mm	Art. No.
32	891063.000000
35	891063.000035
36,65	891017.000000*

*without thread lifter

Rubber suction tube GSR



Features

- Length: 315 mm
- Can be shortened for larger intake opening

Connectors Ø in mm	Art. No.
38	892042.000038

Universal brushes/garment brushes



Connectors Ø in mm	Colour/material	Art. No.
29,75	white, soft	892005.000030
32	white, soft	892005.000032
35	white, soft	892005.000035
35	transparent, hard	892085.000035

Tube brushes



For tube diameter up to 200 mm

Connectors Ø in mm	Art. No.
35	892010.000035
38	892010.000038
50	892010.000050

For tube diameter up to 100 mm

Connectors Ø in mm	Art. No.
32	892009.000032
35	892009.000035
38	892009.000038

Radiator brush



Suction nozzle with bristles

When using the radiator nozzle the crevice nozzle FD 300 892006.300032 or 892006.300035 is required.

Art. No.
892001.000000

Suction hoses roll goods



Connection

1. Sleeve: \varnothing outer
2. Sleeve: \varnothing inner
3. Nominal diameter hose = \varnothing inner

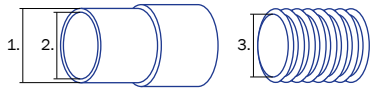

How do I find the right sockets and connectors for the hose?

Fitting with



Doesn't fit

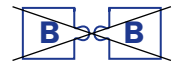

With fabric reinforcement

for wet and dry vacuums aswell as cleaning machines

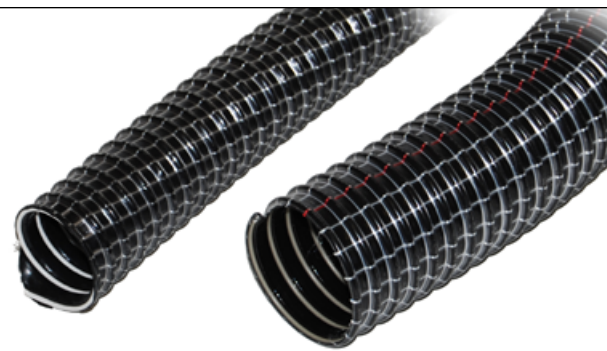

Features

- Black with white fabric and red longitudinal line
- Temperature resistant 0° C to +85° C (short term)

NW* \varnothing mm	Colour	PPE	Art. No.	Fits with
32	black	15 m	900035.15	
38	black	15 m	900001.15	
40	black	15 m	900101.15	
44	black	15 m	900083.15	
51	black	15 m	900034.15	

*Nominal width (NW) = inner diameter

Matching sockets and connectors

Sockets

Fitting with NW* \varnothing mm	Colour	Inner \varnothing /mm	Outer \varnothing /mm	Art. No.	Fitting with
32	black	32	38	900055.000000	
38	black	38	45	900032.000000	
51	black	51	57	900057.000000	

*Nominal width (NW) = inner diameter



Connectors

Fitting with NW* \varnothing mm	Colour	Art. No.	Fitting with
32 - 32	black	900054.000000	
38 - 38	black	900031.000000	
51 - 51	black	900056.000000	

*Nominal width (NW) = inner diameter



Standard hoses

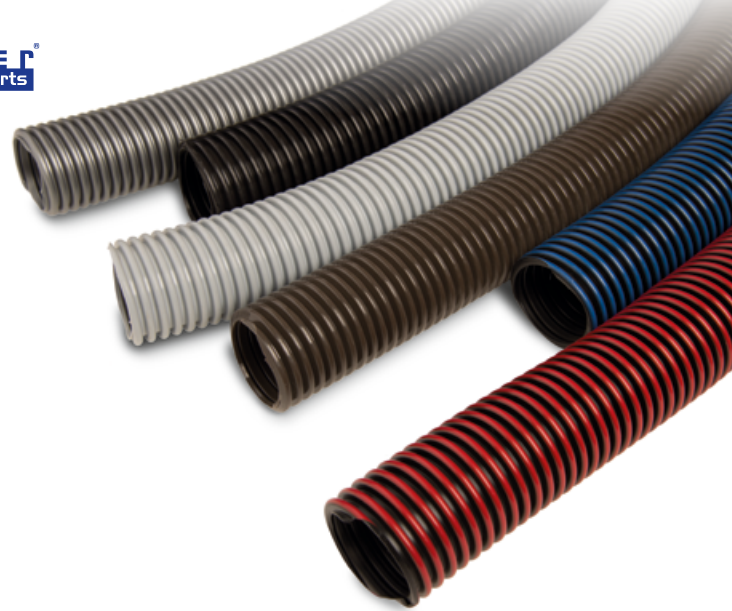

Features

- Vacuum resistance up to ca. 5 m WS (mmH₂O)
- Temperature resistance -45° C to +65° C

NW* Ø mm	Colour	PPE	Art. No.	Fitting with
32	black	20 m	900003.20**	X
36	black	20 m	900016.20**	
38	black	20 m	900002.20**	Y
51	black	20 m	900019.20**	Z
27	silver	30 m	900052.30	W
32	silver	30 m	900201.30	X
36	silver	20 m	900014.20	
36	silver	30 m	900202.30	
38	silver	30 m	900203.30	Y
51	silver	30 m	900204.30	Z
32	black-blue	20 m	900070.20	X
36	black-blue	20 m	900089.20	
38	black-blue	20 m	900072.20	Y
51	black-blue	20 m	900090.20	

*Nominal width (NW) = inner diameter

**Antistatic, surface resistance <10¹¹ Ω

Other nominal sizes and colors on request.

Hand pipe bends

Plastic with air slide (universal)



Fitting with pipe NW* Ø mm	Fitting with Hose NW* Ø in mm	Art. No.	Fitting with
32	32	891079.000032	X
35	32	891079.000035	X
36,65	32	891011.000000	X

*Nominal width (NW) = inner diameter

Matching connection parts

Click ring

NW* Ø mm	Art. No.	Fitting with
32	900064.000000	X

*Nominal width (NW) = inner diameter



Socket, screwable

NW* Ø mm	Art. No.	Fitting with
32	900065.000000	X

*Nominal width (NW) = inner diameter



Sockets and connectors

Connector for suction hose (standard)

Fitting with NW* Ø in mm	Colour	Art. No.	Fitting with
32 - 32	black	900021.000000	X _q
38 - 38	black	900008.000000	Y _q
51 - 51	black	900030.000000	Z _q

*Nominal width (NW) = Inner diameter



Screw-on sockets for suction hose (standard)

Fitting with NW* Ø in mm	Colour	Inner Ø/mm	Outer Ø/mm	Art. No.	Fitting with
32	black	38	45	900023.000000	X _q
32	black	32	38	900025.000000	X _q
38	black	38	45	900009.000000	Y _q
38	black	37	42	900009.000001	Y _q
38	black	45	52	900010.000000	Y _q
38	grey	51	58	900011.000000	Y _q
51	black	51	57	900029.000000	Z _q

*Nominal width (NW) = Inner diameter

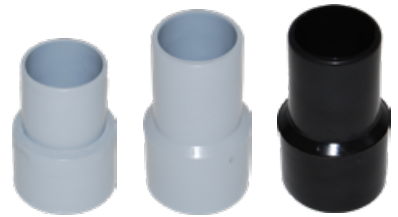

Tool sleeve

Fitting with NW* Ø in mm	Colour	Inner Ø/mm	Outer Ø/mm	Art. No.	Fitting with
27	black	various	25,5 mm / 31 mm / 35 mm	900066.000000	W _q
32	black	various	32 mm / 36 mm / 35 mm	900062.000000	

*Nominal width (NW) = Inner diameter



Device connection sleeve, fitting with Clean Track / Redstreak

Fitting with NW* Ø in mm	Colour	Inner Ø/mm	Outer Ø/mm	Art. No.	Fitting with
38	black	verschiedene	verschiedene	891023.000000	Y _q

*Nominal width (NW) = Inner diameter



Rotatable appliance connection sleeve, fitting with Nilfisk

Fitting with NW* Ø in mm	Colour	Inner Ø/mm	Outer Ø/mm	Art. No.	Fitting with	Pic
32	black		58	891235.000000	X _q	①
51	black		58	891238.000000	Z _q	②

*Nominal width (NW) = Inner diameter



Device connection sleeve, rotatable with screw sleeve and click ring

Fitting with NW* Ø in mm	Colour	Inner Ø/mm	Outer Ø/mm	Art. No.
38	black	38	45	900058.000000

*Nominal width (NW) = Inner diameter





Electrically conductive

Surface resistance $<10^6 \Omega$



Features

- Vacuum resistance up to ca. 5 m WS (mmH₂O)
- Temperature resistant (-25° C to +65° C)
- Antistatic according to DIN 53482

NW* Ø in mm	Colour	Packaging unit	Art. No.	Fitting with
32	black	20 m	900037.20	
36	black	20 m	900039.20	
38	black	20 m	900041.20	
51	black	20 m	900043.20	

*Nominal width (NW) = Inner diameter



Antistatic

Surface resistance $<10^8 \Omega$



Features

- Vacuum resistance up to ca. 5 m WS (mmH₂O)
- Temperature resistant (-25° C to +65° C)
- Antistatic according to DIN 53482

NW* Ø in mm	Colour	PU	Art. No.	Fitting with
32	yellow-black	20 m	900036.20	
36	yellow-black	20 m	900038.20	
38	yellow-black	20 m	900040.20	
51	yellow-black	20 m	900042.20	



*Nominal width (NW) = Inner diameter

Sleeve electrically conductive / antistatic

Fitting with for electrically conductive and antistatic hoses



Sleeves, electrically conductive $<10^6 \Omega$

NW* Ø in mm	Colour	Inner Ø/mm	Outer Ø/mm	Art. No.	Fitting with
32	black	32	38	900120.000000	
38	black	38	45	900122.000000	
51	black	51	57	900124.000000	

*Nominal width (NW) = Inner diameter fitting with hose

Oil resistant



Features

- Material: Polyester elastomer
- Temperature resistant (-60° C bis +120° C)

NW* Ø in mm	Colour	PU	Art. No.	Fitting with
36	brown / brown	4 m	900102.04	
36	brown / brown	20 m	900103.20	
51	brown / brown	4 m	900108.04	

*Nominal width (NW) = Inner diameter

**No reference to original spare part - OEM-No. is only used for allocation to spare parts.

Pre-assembled suction/drain hoses for automatic cleaning machines

Features

- Suction hose with fabric reinforcement
- Socket or crimp nozzle with cover
- End connection



Fitting with Brand

Brand	Modell	Type	NW Ø mm	Colour	Length	Artikel no.	OEM-Nr.
Columbus	K30, RA40, RA43-K30, RA60-KM	A	38	black	620 mm	SLA00001	20 616 303
	RA20, RA40, RA60	A	38	black/white	845 mm	SLA00002	20 616 304
	RA20, RA40, RA55, RA60	A	38	black/grey	850 mm	SLA00003	20 616 301
	RA43, RA55, RA66, RA100	S	38	grey	910 mm	SLA00004	20 643 631
Comac	Vispa 35B/35E	S	29	black	1.250 mm	SLA00014	213041
	Vispa 35B/35E	A	20	black	1.600 mm	SLA00015	421746
		S	38	black/grey	1.340 mm	SLA00123	0438617
		A	50	black/grey	1.280 mm	SLA00124	0438178
		A	38	black/grey	425 mm	SLA00125	0438622
		A	38	black/grey	830 mm	SLA00126	0434151
		S	38	black/grey	1.070 mm	SLA00127	0432091
		A	38	black/grey	1.500 mm	SLA00128	0436196
Fimap	Gamma 35E	S	29	black	1.250 mm	SLA00014	
	Gamma 35E	A	20	black	1.600 mm	SLA00015	
Dr. Gansow		S	38	black	1.020 mm	SLA00130	202120
		A	38	pearly green	760 mm	SLA00131	
		A	38	pearly green	1.050 mm	SLA00132	
Gansow/Gmatic	60 B/BT 62, 75 B/BT 70, 80 B 82 90 B/BT 82, 105 BT 82, 105 BT 92	A	38	black	800 mm	SLA00121	14718
	80 B 82	S	38	black	1.020 mm	SLA00090	202120
	80 B 82	A	38	pearly green	760 mm	SLA00118	
Hako	E/B450, E/B530, B650, B655S, B755S, B855S, E/B750R, E/B850 5450 Power Flow	A	38	black	800 mm	SLA00099	00671510
	E/B450, E/B530	S	38	black	698 mm	SLA00031	00340930
	E/B750R	A	38	black	1.030 mm	SLA00033	03170140
	E/B750R, B910	S	38	black	1.370 mm	SLA00034	01071560
	B910	A	50	black	890 mm	SLA00103	
	B30, B45	S	38	black	1.150 mm	SLA00028	01173300
	B30, B45, B70, B90	A	20	transparent	700 mm	SLA00029	01177440
	B30, B45, B70, B90	A	38	black	970 mm	SLA00098	01276140 ersetzt 01177080 & 01077960
	B70, B90	S	38	black	1.280 mm	SLA00030	01077920
	B75R	S	38	black	1.460 mm	SLA00101	01171610
	B75R	A	38	black	770 mm	SLA00102	01278210
	B115R, B120R	A	38	black	1.030 mm	SLA00033	03170140
	B115R	S	38	black	1.370 mm	SLA00034	01071560
B120R	S	38	black	1.700 mm	SLA00136	01370150	

S suction hose | A drain hose waste water | FA drain hose fresh water

Suction/drain hoses for automatic cleaning machines

Fitting with Brand	Modell	Type	NW Ø mm	Colour	Length	Artikel no.	OEM-Nr.
IPC-Gansow	26B46	A	38	black	620 mm	SLA00105	
	CT40, CT70	A	38	black	845 mm	SLA00005	TBFX00348, TBFX00358
	CT 40, CT 70, CT 90	S	32	black	1.100 mm	SLA00006	TBBP00407
	CT160	A	50	grey	1.050 mm	SLA00092	
Kärcher	B40C, B40W, B60W	A	38	black	1.080 mm	SLA00094	
	B60W	S	38	black	660 mm	SLA00008	6.392-267.0
	B90R, B140, BD75, BD90, BD700 BR75, BR90, BR700	A	36	black	900 mm	SLA00012	6.390-829.0
	B90R, B140, BD75, BD90, BD700 BR75, BR90, BR700	S	38	black	1.000 mm	SLA00013	6.391-593.0
	BD65/80, BD550, BD750, BD-Trike BR65/80, BR530, BR550, BR550XL BR750, BR-Trike	A	38	black	750 mm	SLA00009	6.392-333.0, 6.390-734.0
	BD530, BR530	S	32	black	850 mm	SLA00011	4.390-002.0
	BD530, BD530XL, BR530, BR530XL	A	32	black	650 mm	SLA00010	4.446-010.0, 6.390-733.0
Kenter	Vispa 35	S	29	black	1.250 mm	SLA00024	
	Vispa 35	A	20	black	1.600 mm	SLA00025	
Nilfisk-Advance	BA410, BA430, BA510S, BA530 SC400	A	38	grey	970 mm	SLA00018	9099692000
	BA451, BA530, BA531, BA550 BA551, BA650S, BR551CD	A	38	grey	1.480 mm	SLA00019	9099165, 9100001892
	BA451, BA531, BA551, BA600S BA650, BA750S	S	38	black	1.250 mm	SLA00119	9099853000
	BA611D, BA651, BA751, BA851 BR751C	A	38	black	1.800 mm	SLA00021	9097618000
	BR600, BR800, BR850, BR1050S BR1300SC	A	38	grey	1.070 mm	SLA00095	566001401, 56381918
	BR601, BR752	A	35	grey	970 mm	SLA00022	9096096000
	BR700, BR755, BR855	S	40	grey	1.070 mm	SLA00023	56381921
	BR1100, BR1300	S	50	black	1.980 mm	SLA00097	56413377
	BR1100, BR1300S	A	41	grey	1.260 mm	SLA00096	56381937
	SC400, SC450	S	35	black	960 mm	SLA00111	
	SC401	A	38	black	1.000 mm	SLA00113	9100002443
	SC401	S	38	black	610 mm	SLA00114	9100002444
Nilfisk-Alto	Scrubtec 553	A	38	grey	1.480 mm	SLA00036	9099165, 9100001892
	Scrubtec 661	S	38	black	1.250 mm	SLA00119	9099853000
	Scrubtec 661	A	38	black	1.800 mm	SLA00021	9097618000
Numatic	ET4045, ETB4045, TT4045, TT4055 TTB4045, TTB4055	S	35	black	698 mm	SLA00017	280019
	ET4045, ETB4045, TT4045, TT4055 TTB4552, TTB6055, TTV4555 TTV5565, TTV678	A	36	black	780 mm	SLA00016	280018
Sprintus	Camira	S			2.300 mm	SLA00141	210190
	Camira, Torana	A			300 mm	SLA00140	210173
	Tortuga	A	27	black	165 mm	SLA00138	210160
	Tortuga	S	20	black	1.495 mm	SLA00137	210116
Tennant	T3, T5, T7, T7 Plus	A	38	black	800 mm	SLA00038	1043538
	T3, T5, T7, T7 Plus	S	38	black	1.450 mm	SLA00109	1014026
	T300	A	38	black	620 mm	SLA00110	1213008
	T300	S	38	black	698 mm	SLA00122	1204663

Kein Hinweis auf Original Ersatzteil - OEM-Nr. dient nur der Zuordnung zu Ersatzteilen

S suction hose | A drain hose waste water | FA drain hose fresh water

Pre-assembled suction hoses

Features

- Pre-assembled suction hoses
- Perfect fit for your vacuum cleaner
- With socket or hand tube
- Incl. boiler inlet nozzle



Fitting with Cleanfix



Fitting with Nilfisk

Fitting with

Brand	Model	NW Ø in mm	Colour	Length	Artikel no.	OEM-Nr.
Cleanfix	S10, S10+, S12 (altes Modell)	32	silver	2.500 mm	SAU00004	012.567
Clean Track VacLine	270 PUMP Automatic vacuum	38	black	5.000 mm	SAU00730	
	PumpLine 70, VacLine 30, VacLine 70, VacLine 80 VacLine 90	38	black/blue	3.500 mm	SAU00747	
	VacLine 15	32	black/blue	3.500 mm	SAU00742	
	VacLine 70 Big Mouth	51	black	5.000 mm	SAU00758	
Columbus	ST7, ST11	32	black	2.500 mm	SAU00008	21 000 900
	SW30, SW50, SW52, SW53	38	black/blue	3.500 mm	SAU00867	20 539 201
	SW32	38	black	3.000 mm	SAU00645	21 056 730
Ecolab	Floormatic Blue Vac 11, S12	32	silver	2.500 mm	SAU01091	
Ghibli	T1	32	black	1.800 mm	SAU00020	
Henkel	Floormatic Blue Vac 11, S12	32	silver	2.500 mm	SAU00843	
Hitachi	CV400P	36	silver	30.000 mm	SAU00980	
Kärcher	IVC 60/12, IVC 60/24, IVC 60/30, IVM 60/30, IVM 60/36, IVR 40/15, IVR 50/15, IVR-B 20/8, IVR-B 30/15	40	black/white	15.000 mm	SLA00139	9.989-633.0
	IVC 60/24-2, IVR 40/24-2, IVR 50/24-2, IVR 100/24-2, IVR-L/VR-L 100/24-2, IVR-L/VR-L 120/24-2, IVR- L/VR-L 200/24-2, IVR-L/VR-L 400/24-2, NT25/1 NT30/1, NT35/1, NT40/1, NT45/1	32	yellow/black	5.000 mm	SAU00825	
	IVR 40/24-2, IVR 50/24-2, IVR 100/24-2, IVR-L/VR-L 100/24-2, IVR-L/VR-L 120/24-2, IVR-L/VR-L 200/24-2, IVR-L/VR-L 400/24-2	51	black/white	15.000 mm	SAU00672	9.989-634.0
	NT35/1	35	black	2.500 mm	SAU00049	4.440-626.0
	T7/1	32	black	2.500 mm	SAU00660	4.440-907.0
Nilfisk- Advance	GD930	32	silver		SAU00122	
	GD1005, GM80, VP300	32	silver	1.800 mm	SAU00131	1470765510
	UZ 934	32	black	2.000 mm	SAU00256	
	VL 500-55, VL 500-75	51	black	20.000 mm	SAU00675	11984
Nilfisk-Alto	Attix, IVB 961-0L, IVB 965 SD-XC, Maxxi II, VHS 40 VHS 42 M-H, System 50	50	black	4.000 mm	SAU00199	15358
	System 36	36	black	20.000 mm	SAU00699	15312
	System 36	36	brown	4.000 mm	SAU00700	6429

Konfektionierte Saugschläuche

Fitting with

Brand	Model	NW Ø in mm	Colour	Length	Artikel no.	OEM-Nr.
	System 36	36	brown	20.000 mm	SAU00701	6429
	System 38	38	black	4.000 mm	SAU00968	302002796
	System 38	38	silver	30.000 mm	SAU00702	107400052
	System 50	51	black	20.000 mm	SAU00703	7599
	System 50	50	brown	4.000 mm	SAU00704	14238
	System 50	51	silver	30.000 mm	SAU00705	11984
Numatic	Henry, TEL390, WV370, WV570, WV800, WV900	32	black	3.000 mm	SAU00093	601102
	Henry, TEL390, WV370, WV570, WV800, WV900	32	black	2.500 mm	SAU00092	601101
	NDD570, NDD900, NED570, NED900, WVD570, WVD900, WVD1800	38	black	2.500 mm	SAU00116	602102
	NDD570, NDD900, WVD570, WVD900, WVD1800	38	black	2.900 mm	SAU01099	602103V
	NDD570, NDD900, WVD570, WVD900, WVD1800	38	black	4.000 mm	SAU01100	602104V
	NDD570, NDD900, WVD570, WVD900, WVD1800	38	black	5.000 mm	SAU01101	602105V
	NDD570, NDD900, WVD570, WVD900, WVD1800	38	black	6.000 mm	SAU01102	602106V
	NDD570, NDD900, WVD570, WVD900, WVD1800	38	black	7.000 mm	SAU01103	602107V
	NDD570, NDD900, WVD570, WVD900, WVD1800	38	black	8.000 mm	SAU01104	602108V
Redstreak	ISR 115	32	black/red	3.500 mm	SAU00257	
	ISR 130, ISR 360, ISR 380, ISR 390	38	black	3.500 mm	SAU01072	
Sorma	510, 3410	32	black	2.800 mm		900086.000000
Sprintus	Ares, Floory, Maximus, N28/1-E, T11	32	black	2.500 mm	SAU00072	106.025
Taski	Bora	32	black	2.800 mm	SAU01079	
Wirbel	W1	32	black	1.800 mm	SAU00724	

Disposal hoses for pump vacuum cleaners



Features

- Tear-resistant drain hoses
- With Storz coupling on both sides
- Available in three lengths

Connectors* Ø in mm	Connector	Length	Art. No.
52	C-Schlauch / Storz Anschluß beidseitig	10 m	900140.000000
52	C-Schlauch / Storz Anschluß beidseitig	20 m	900140.000020
52	C-Schlauch / Storz Anschluß beidseitig	30 m	900140.000030

*Nominal width (NW)

Extension tubes

Features

- Extension tubes made of Plastic, chrome-plated and stainless steel
- Impact-resistant and dimensionally stable
- Ideal for all common suction cups available

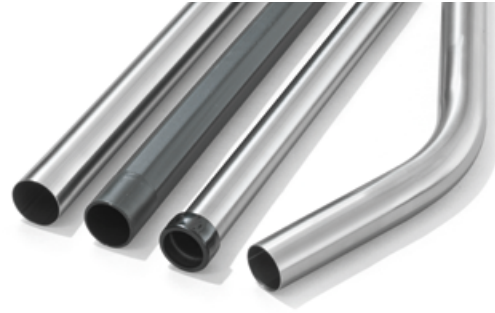

Telescopic tubes



Connectors* Ø in mm	Material	Length/mm	PU	Art. No.
35	Aluminium	up to 1000	40	891056.000000
32	Chrome	up to 900	40	892130.000000

*Nominal width (NW)

Extension tubes and hand tube bends



Straight

Connectors* Ø in mm	Length in mm	PU	Art. No.	Pic
32**	500	50	891084.500032	①
35**	500	40	891084.500035	①
38	470	40	891084.470038	③

*Nominal width (NW) = inner diameter - **Incl. plastic ring

Curved

Connectors* Ø in mm	Length in mm	PU	Art. No.	Pic
32	420 with air slide	25	891085.420032	④
35	500 with air slide	20	891085.370035	②
38	470 with air slide	20	891085.470038	②

*Nominal width (NW) = inner diameter

Verchromt



Straight

Connectors* Ø in mm	Length in mm	PU	Art. No.	Pic
32	500	50	891074.000032	①
Reduzierung 35 → 32	140	50	891241.000000	
35	500	40	891074.000035	①
36,65	500	40	891086.000000	①
50	500	20	891074.000050	①

*Nominal width (NW) = inner diameter

Curved

Connectors* Ø in mm	Length in mm	PU	Art. No.	Pic
32	470 without air slide	25	891075.000032	②
38	470 without air slide	25	891075.000038	②
50	500 without air slide	10	891075.000050	②

*Nominal width (NW) = inner diameter

Plastic



Straight

Connectors* Ø in mm	Length in mm	PU	Art. No.
32	450	25	892120.000032
35	450	25	892120.000035

*Nominal width (NW) = inner diameter



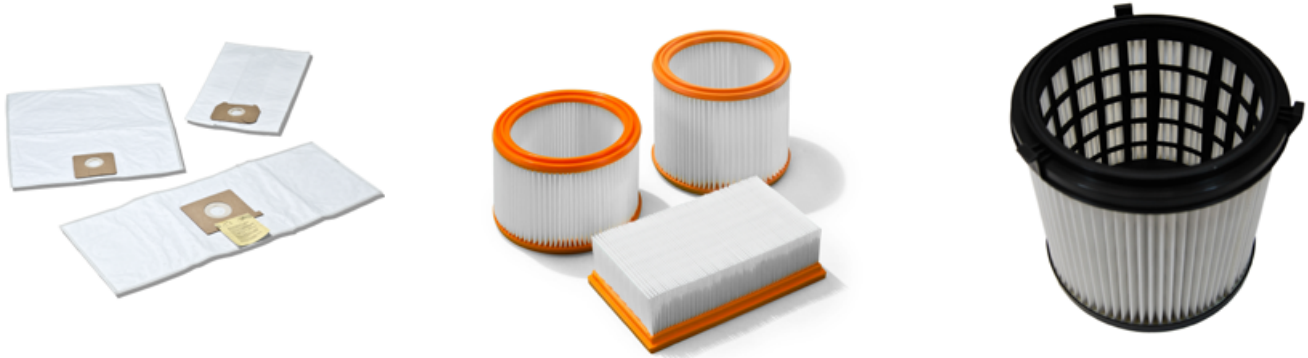

We stock filters for the following manufacturers:

Black & Decker	Hako	Nilfisk-Advance	Sorma
Blitz Fritz	Harema	Nilfisk-Alto	Soteco
Bosch	Henkel	Numatic	Sprintus
Clean Track	Hilti	Oehme-Lorito	Starmix
VacLine	Kärcher IBO	Öhlrich	Stihl
Cleanfix	Kenter	Pool	Taski
Columbus	Mafell	Profi Europe	Tennant IBO
Eibenstock	Makita	Protool	Vermop
Electrolux	MCP	Redstreak	Vorwerk
Fein	Menzer	Renfert	WAP
Festool	Metabo	Rokamat	Wetrok
Flex	Mobilotech	Rowenta	Wirbel
Floordress	Nilco	Sebo	
Ghibli	Nilfisk	Selco	

Flat pleated filters, filter cartridges, chip screens

Brand	Model	Article No.	OEM-Nr.	Article name	Measurements
Bosch	GAS 15, GAS 20	FIL00117		Filter cartridge Dust category M – Material PET plastic	185 x 140 mm
	GAS 35 L AFC, GAS 35 L SFC+, GAS 35 M AFC, GAS 55 M AFC Professional	FIL00372		Flat pleated filter – Material paper	239 x 140 x 56 mm
	GAS 35 L AFC, GAS 35 L SFC+, GAS 35 M AFC, GAS 55 M AFC Professional	FIL00373		Coarse dirt filter	239 x 140 x 15 mm
Clean Track	PumpLine 70	FIL00360		Coarse dirt filter bag	
Columbus	SW32-P / SW32-S	FIL00280	21 056 000	Filter cartridge – Material PET plastic	190 x 195 mm
Electrolux	GD 930, UZ 930 S	FIL00452		Filter cartridge – Material PET plastic	Diameter 370 mm / filter insert square 210 mm
Fein	Dustex 25L, Dustex 35L	FIL00365	31345059010	Flat pleated filter Dust category M – Material PET plastic	239 x 140 x 56 mm
Festool	CTL 22 E	FIL00320	452 065	Flat pleated filter Dust category M – Material paper	215 x 115 x 58 mm
	SR 151 LE-AS, SR 152 LE	FIL00322	488 461	Filter cartridge – Dust category M – Material PET plastic	185 x 115 mm
	SRM 45 LE-EC, SRM 70 LE-EC	FIL00118	485 808	Filter cartridge Dust category M – Material PET plastic	185 x 140 mm

Flat pleated filters, filter cartridges, chip screens

Brand	Model	Article No.	OEM-Nr.	Article name	Measurements
Flex	S 36, S 36 M, S 47, S 47 M, VCE 35 L AC, VCE 35 L MC, VCE 45 L AC	FIL00448		Flat pleated filter – Material paper	239 x 140 x 56 mm
	S 36, S 36 M, S 47, S 47 M, VCE 35 L AC, VCE 35 L MC, VCE 45 L AC	FIL00449		Coarse dirt filter	239 x 140 x 15 mm
Hako	VC380-H / VC380-W	FIL00425		Filter cartridge Dust category M – Material PET plastic	185 x 115 mm
Hilti	VC20-U, VC40-U	FIL00367		Flat pleated filter Dust category M – Material PET plastic	239 x 140 x 56 mm
	VC20-U, VC40-U, WVC40-M	FIL00368		Flat pleated filter – Material paper	239 x 140 x 56 mm
	VC20-U, VC40-U, WVC40-M	FIL00369		Coarse dirt filter	239 x 140 x 15 mm
	VC40-U	FIL00370	287442	Filter cartridge Dust category M – Material PET plastic	275 x 186 mm
Kärcher	2201, 2901 F, 3000 Plus, A1000, A1001, A2004, A2024pt, A2054me, A2064pt, A2101, A2131pt, A2200, A2201, A2204, A2206x, A2231pt, A2234pt, A2251me, A2254me, A2504, A2534pt, A2554me, A2901, K2301, MV2, MV3, NT27/1, SE 4001, SE 4002, VC6200, VC6300, WD2, WD2.200, WD2.240, WD3, WD3.200, WD3.500p, WD3.540p, WD3.600mp, WD3300	FIL00029	6.414-552.0	Filter cartridge – Material paper	112 x 123 mm
	2501, 2801, K2000, K3500, K3501, NT14/1, NT221, NT350, NT351	FIL00031	6.904-156.0 / 6.904-068.0	Flat pleated filter Dust category M – Material paper	215 x 115 x 58 mm
	A2701, A2731, A2801, K2501, K2601, K3001, NT181, SE 2001, SE 3001, SE 5.100, SE 5001, SE 6.100	FIL00047	6.414-498.0	Flat pleated filter Dust category M – Material paper	202 x 75 x 70 mm
	KM70/30C-Bp, NT25/1, NT30/1, NT35/1, NT40/1, NT45/1, NT50/1, NT55/1, NT611, SB-V1	FIL00025	6.904-367.0	Flat pleated filter – Material paper	239 x 140 x 56 mm
	KM70/30C-Bp, NT25/1, NT30/1, NT35/1, NT40/1, NT45/1, NT50/1, NT55/1, NT611, SB-V1	FIL00026	6.904-287.0	Coarse dirt filter	239 x 140 x 15 mm
	MV4, MV5, MV6, WD4, WD5, WD6	FIL00034	2.863-005.0	Flat pleated filter – Material PET plastic	163 x 104 x 50 mm
	NT25/1, NT30/1, NT35/1, NT40/1, NT45/1, NT50/1, NT55/1, NT611	FIL00035	6.904-360.0	Flat pleated filter Dust category M – Material PET plastic	239 x 140 x 56 mm
	NT361, NT561, NT611, NT65/2 – bis 2008, NT65/2 – 2009 bis 2014, NT65/2 – ab 2014, NT72/2, NT75/1, NT75/2	FIL00043	6.904-276.0 / 6.904-283.0	Flat pleated filter – Material paper	300 x 140 x 68 mm
	NT55/2 (bis S.-Nr. 40000), NT65/2 (ab S.-Nr. 40001), NT75/2 (ab S.-Nr. 40001), NT75/2 (bis S.-Nr. 40000)	FIL00041	6.907-276.0	Flat pleated filter Dust category M – Material paper	300 x 140 x 68 mm for Tact ²
	NT551, NT700, NT702	FIL00046	5.731-020.0	Flat pleated filter Dust category M Material paper	278 x 216 x 54 mm
	NT65/2 – bis 2008, NT65/2 – 2009 bis 2014, NT65/2 – ab 2014, NT75/2	FIL00042	6.907-277.0 / 6.904-284.0	Flat pleated filter Dust category M – Material Polyesterlives	300 x 140 x 68 mm for Tact ²
	WD4200, WD5300, WD5400, WD5600, WD5000 bis, WD5999	FIL00053	6.414-960.0	Filter cartridge – Material paper	177 x 90 mm

Flat pleated filters, filter cartridges, chip screens

Brand	Model	Article No.	OEM-Nr.	Article name	Measurements
Makita	443	FIL00377	W29747	Filter cartridge Dust category M – Material PET plastic	185 x 115 mm
	446 L, 446 LX, P-70219 VC2010L, VC2512L, VC3011L, VC3511L	FIL00399		Filter cartridge Dust category M – Material PET plastic	185 x 140 mm
	447 L, 447 M	FIL00378	P-70225	Filter cartridge Dust category M – Material PET plastic	275 x 186 mm
	VC2012L, VC2512L, VC3011L, VC3012L, VC3012M	FIL00376	P-70219	Filter cartridge – Dust category M – Material paper	180 x 140 mm
MCP	X1 Secco, X2 Aqua, X2 Auto	FIL00461		Flat pleated filter HEPA – Material PET plastic	130 x 58 mm
Nilco	S 20, S 20 L	FIL00284		Filter cartridge	75 x 210 mm
Nilfisk-Advance	GD930	FIL00394		Flat pleated filter – Material PET plastic	Diameter 370 mm / Filter insert square 210 mm
	IVB 3 (from model year 2008) IVB 5 (from model year 2008) IVB 9 (from model year 2008)	FIL00410	11753 / 302000490	Filter cartridge Dust category M – Material PET plastic	185 x 140 mm
	Nilfisk-Alto	Aero 20, Aero 21, Aero 25 Aero 26, Aero 31, Aero 35 Aero 400, Aero 440, Aero 640, Aero 840, Attix 3 (ab Modell 2008), Attix 30, Attix 350, Attix 360, Attix 40, Attix 50, Attix 550, Attix 560, Attix 590, SQ 650	FIL00116	11753 / 302000490	Filter cartridge Dust category M – Material PET plastic
	Attix 33, Attix 44	FIL00438	107413540	Flat pleated filter PTFE M – Class A	247 x 176 x 55 mm
	Attix 9 (ab Modell 2008) Attix 560, Attix 761, Attix 763, Attix 961, Attix 963, Attix 965	FIL00099	107400562	Filter cartridge Dust category M – Material PET plastic	275 x 186 mm
	SQ 450, SQ 490-31	FIL00102	29747	Filter cartridge Dust category M – Material PET plastic	185 x 115 mm
	SQ 690, SQ 850-11	FIL00103	61605	Flat pleated filter Dust category M – Material paper	328 x 290 x 50 mm
	Turbo XL / Turbo 1001 (K1, SA)	FIL00102	29747	Filter cartridge Dust category M – Material PET plastic	185 x 115 mm
Profi Europe	Profi 1	FIL00456		Filter cartridge – Material PET plastic	245 x 30 mm
Protool	VCP 250 E	FIL00458		Filter cartridge Dust category M – Material PET plastic	185 x 140 mm
	VCP 450 E-L	FIL00384	626 437	Filter cartridge Dust category M – Material PET plastic	275 x 186 mm
	VCP 700 E	FIL00384	626 437	Filter cartridge Dust category M – Material PET plastic	275 x 186 mm
Renfert	Vortex Compact 2 EC 230 Vortex Compact 2 L 120 Vortex Compact 2 L 230 Vortex Compact EC 2 M 230V	FIL00381		Filter cartridge Dust category M – Material PET plastic	185 x 115 mm
Sorma	510, 3410, SM 505	FIL00334		Filter cartridge – Material PET plastic	H 103 mm / IØ 129,5 mm / OØ 160 mm
	Aspra 100, Aspra 200	FIL00335		Filter cartridge – Material PET plastic	H 160 mm / IØ 142 mm / OØ 220 mm
Stihl	Filter Stihl	FIL00391	4709 703 5900	Filter cartridge Dust category M – Material paper	180 x 140 mm
	SE 120	FIL00392	4727 703 5900	Filter cartridge Dust category M – Material PET plastic	185 x 115 mm
Tennant	3400, V5	FIL00113		Filter cartridge – Material PET plastic	H 103 mm / IØ 129,5 mm / OØ 160 mm
Vorwerk	Kobold 130, Kobold 131	FIL00440		Carbon Vorfilter	155 x 80 mm
	Kobold 130, Kobold 131	FIL00441		Fleece exhaust air filter	95 x 85 mm

Flat pleated filters, filter cartridges, chip screens

Brand	Model	Article No.	OEM-Nr.	Article name	Measurements
Vorwerk	Kobold 135	FIL00442		Micro-Vorfilter	115 x 85 mm
	Kobold 135	FIL00443		Fleece exhaust air filter	81 x 71 mm
	Tiger 251, Tiger 252	FIL00446		Carbon Vorfilter	150 x 110 mm
WAP	Filter WAP	FIL00351	61605	Flat pleated filter – Dust category M – Material paper	328 x 290 x 50 mm
	SQ 650-11	FIL00350	302000490	Filter cartridge – Dust category M – Material PET plastic	185 x 140 mm
Wetrok	Monovac 6	FIL00076	042.080	Filter cartridge	H 103 mm / IØ 124 mm / OØ 160 mm
	Monovac 9, Monovac 11	FIL00077	042.082	Filter cartridge	H 195 mm / IØ 124 mm / OØ 160 mm
Wirbel	960, 962	FIL00459	20-770	Filter cartridge – Material PET plastic	
	Backpack vacuum cleaner W1, Backpack vacuum cleaner W1-BC Lithium	FIL00395	2512749	Filter cartridge – Material PET plastic	H 42 mm / IØ 85 mm / OØ 165 mm



Fitting with Kärcher



Fitting with Nilfisk Attix 33 & 44

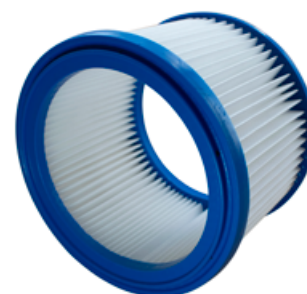

Fitting with Nilfisk Attix 30 & 40

Dust filter bags

We manufacture microfiber fleece dust filter bags for commercial boiler vacuum cleaners to a high technical



Our synthetic non-woven bags:

- are tear-resistant
- have a higher filter performance with a higher suction capacity at the same time
- can be filled up to 95% without loss of suction power (with paper bags, a loss of suction power occurs from approx. 75% filling) are impermeable to water for approx. 15 minutes
- are all 5-ply
- are all shrink-wrapped in the respective PU in foil bags
- are made from recycled PET bottle material and are therefore environmentally friendly

If you purchase full carton units, you will receive an additional 5% discount. For larger quantities, please ask about our attractive special conditions.

Suitable dust filter bags for your vacuum cleaner can be found in our online store:
<https://www.weber-cp.com/shop>



Weber has much more in store!

Your strong partner for industrial and floor cleaning.

Everything from a single source.

Sweeping rollers



For all common machines in standard bristles with plastic, plastic mix, plastic/wire; special solutions also available. For interior and exterior cleaning.

Side brooms



For all common machines in standard bristles with plastic, plastic mix, plastic/wire; special solutions also available. For interior and exterior cleaning.

Disc brushes



Scrubbing, shampoo or polishing brushes – available with various bristle types and bristle arrangements.

Clean Track cleaning machines



From vacuum cleaners to automatic cleaning machines, Clean Track offers you robust technology at an affordable price.

Vacuum motors



For all standard machines and industrial vacuum cleaners with tangential or peripheral exhaust air.

Battery chargers



For wet and gel batteries from 24 to 48 volts. Stationary and on-board devices.

Scrubbing rollers



Scrubbing, shampoo or polishing brushes – available with different bristle types and bristle arrangements.

Cables



With PVC or rubber sheathing, fabric-reinforced versions also available..

Squeegees



Squeegees made of para, nitrile, polyurethane or PVC – for perfect suction results.

Driving plate



Universal and high-speed drive plates for all applications with standard or special pads.

Pads



For all floor cleaning machines: Normal, super, high-speed, microfiber, JPU Diamond, steel wool pads as well as sanding mesh and sanding paper.

Weber Cleaning Parts GmbH

Münsterer Straße 8

D-65618 Selters

Phone +49 (0) 6483 80 469 – 125

Fax +49 (0) 6483 80 469 – 142

www.weber-cp.com

info@weber-cleaningparts.com

